

No	Part #	Description	Application	Qty Req	Price Each
	811 0337	Differential assy, 8/37 (X195)	540 -E11000	1	962.50
	811 2032	Differential assy, 9/41 (X195)	540 E11001-	1	962.50
	ATA7204	Differential assy, 9/38 (X195)	560	1	907.50
1	811 0338	Axle case (U)	-E26992	1	49.50
	ATA7288	Axle case (U)	E26993-	1	49.50
2	2A7103	Nut, RHT		1	16.23
	1G3584	Nut, LHT		1	17.55
3	2A7250	Washer		2	3.58
4	6K499	Drain/filler plug		2	5.34
5	2A7027	Gasket		1	3.25
6	2K5943	Bearing		2	53.35
7	2K7778	Washer, .004"		A/R	2.59
	2A7271	.010"		A/R	3.03
8	ATA7296	Thrust washer		2	4.51
9	2A7015	Pinion gear		2	60.78
10	ATA7297	Thrust washer		2	10.73
11	811 0347	Bearing, inner	540	1	213.40
	ATA7166	Bearing, inner	560	1	108.63

No	Part #	Description	Application	Qty Req	Price Each
12	811 0346	Bearing, outer	540	1	153.73
	ATA7119	Bearing, outer	560	1	50.05
13	ATA7047	Oil seal		1	5.34
14	1G7439	Dust cover (U)		1	15.40
15	FNN612	Nut	560	1	5.34
16	LWZ212	Lockwasher		1	0.83
17	1H3364	Vent		1	7.43
18	2A7242	Axle shaft		2	324.50
19	2A7091	Gasket		2	1.38
20	CMZ0410	Screw		2	1.38
21	2A7087	Hub (U)		2	60.50
22	2A7089	Wheel stud		8	6.77
23	2A8012	Lug nut		8	2.81
24	ATA7225	O-ring		2	3.41
25	BTA108	Oil seal		2	9.08
26	6K584	Bearing		2	23.38

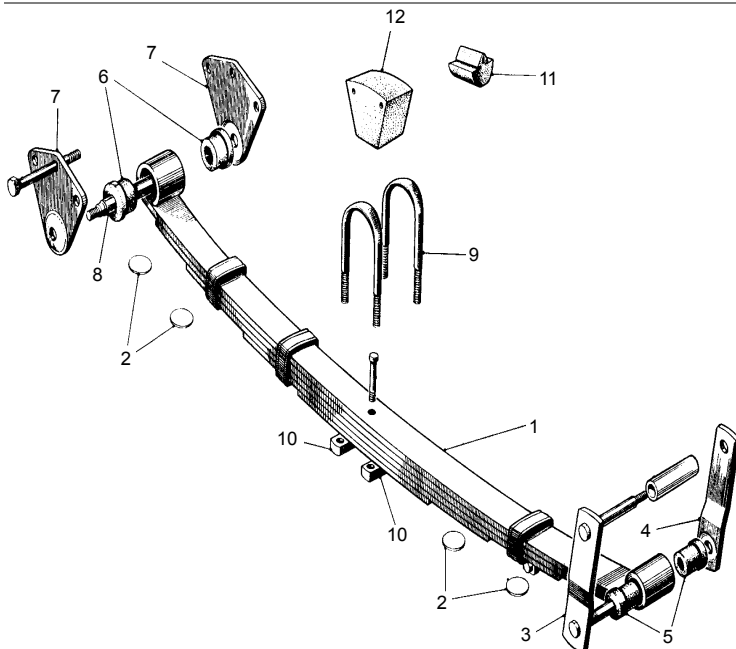

No	Part #	Description	Application	Qty Req	Price Each
	13H384	Jack		1	71.50
	3H2903	Jack handle		1	64.90
	11H169	Tool bag		1	28.60
1	7H1807	Leaf spring		2	357.50
2	7H1808	Spacer, plastic		8	7.43
3	2A5168	Shackle, outer (U)		2	10.73
4	2A5172	Shackle, inner (U)		2	9.35
5	2A5175	Bushing, rear		8	6.00
6	2A5174	Bushing, front		4	19.07
7	2A5167	Hanger (U)		4	9.90
8	2A5173	Pin (U)		2	9.08
9	2A5177	U-bolt (U)		4	6.60
10	2A5178	Bar (U)		4	4.13
11	2A7141	Bumper, center		1	18.43
12	2A7142	Bumper, outer		2	14.69

540 Series cars were originally equipped with 5.20 x 13 bias belted tires.
560 Series cars were originally equipped with 5.60 x 13 bias belted tires.

WHEN USING MODERN TIRE SIZES

145 / 80 R 13 is approximately equivalent to 5.20 x 13 (bias or radial)
155 / 80 R 13 is approximately equivalent to 5.60 x 13 (bias or radial)

Radial tires provide greatly improved ride and handling.
Use of an improper size tire may result in damage to your car.